

Viewing and Modeling

Don Fussell

Computer Science Department

The University of Texas at Austin



A Simplified Graphics Pipeline

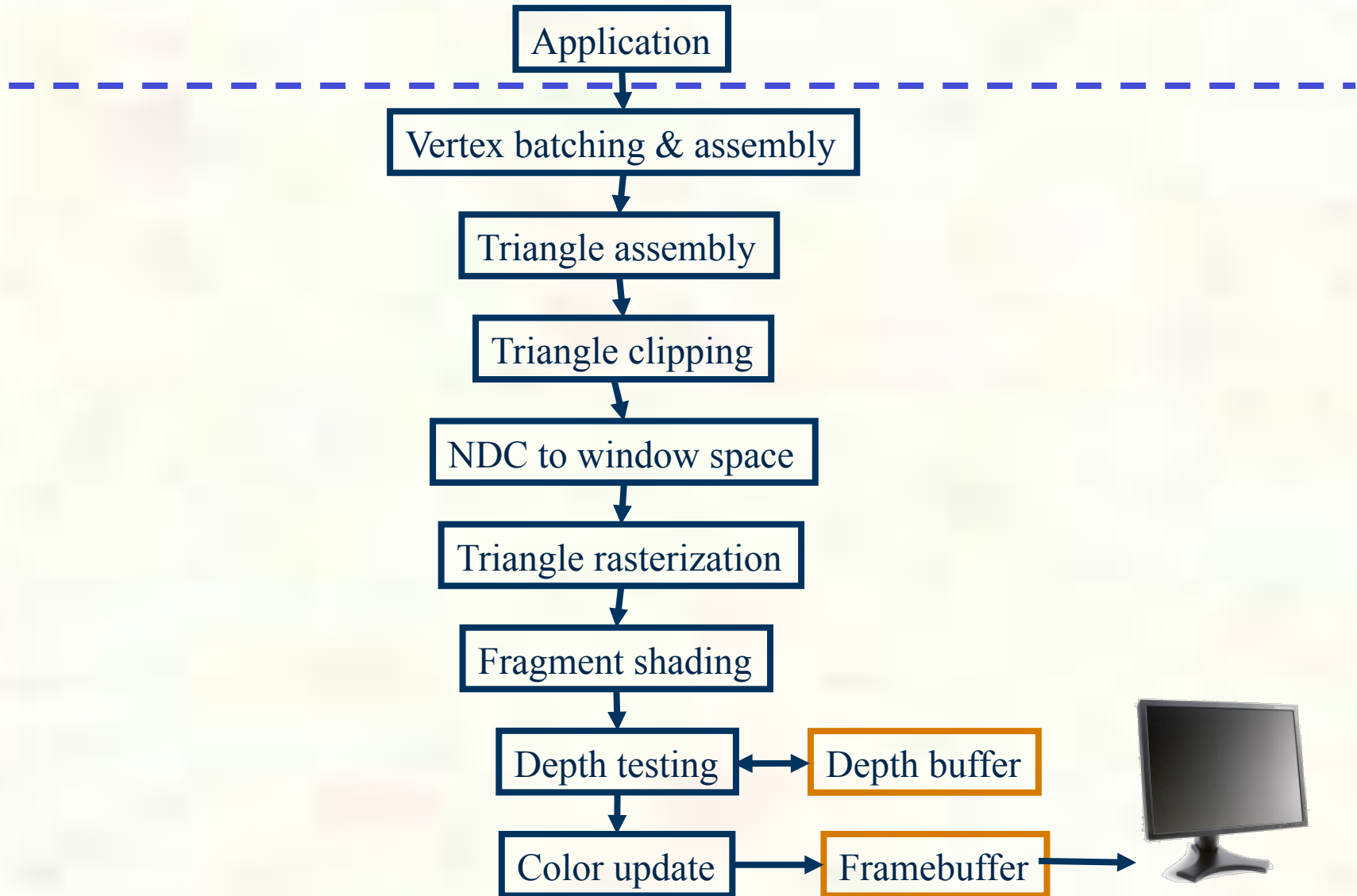



A few more steps expanded

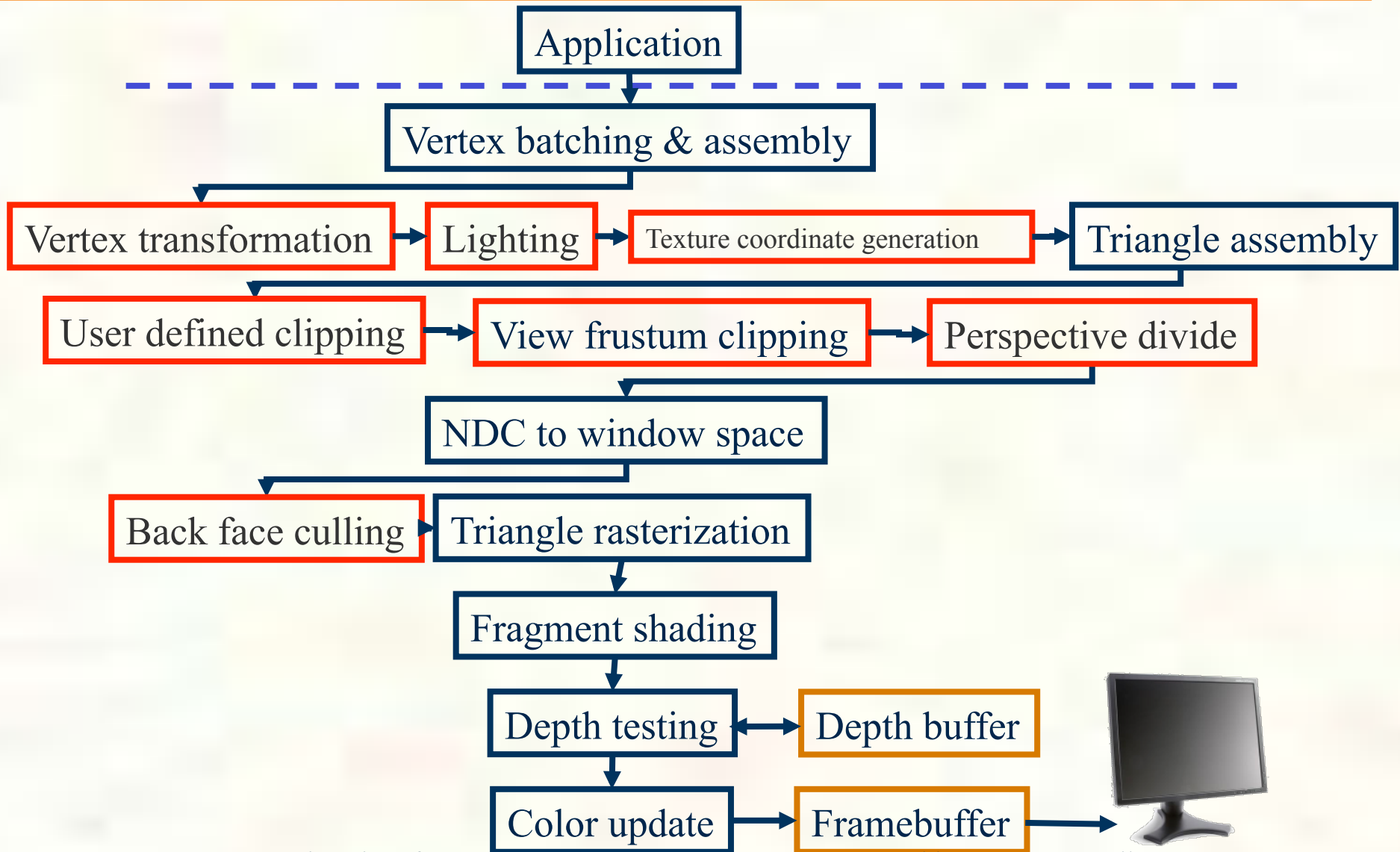



Conceptual Vertex Transformation

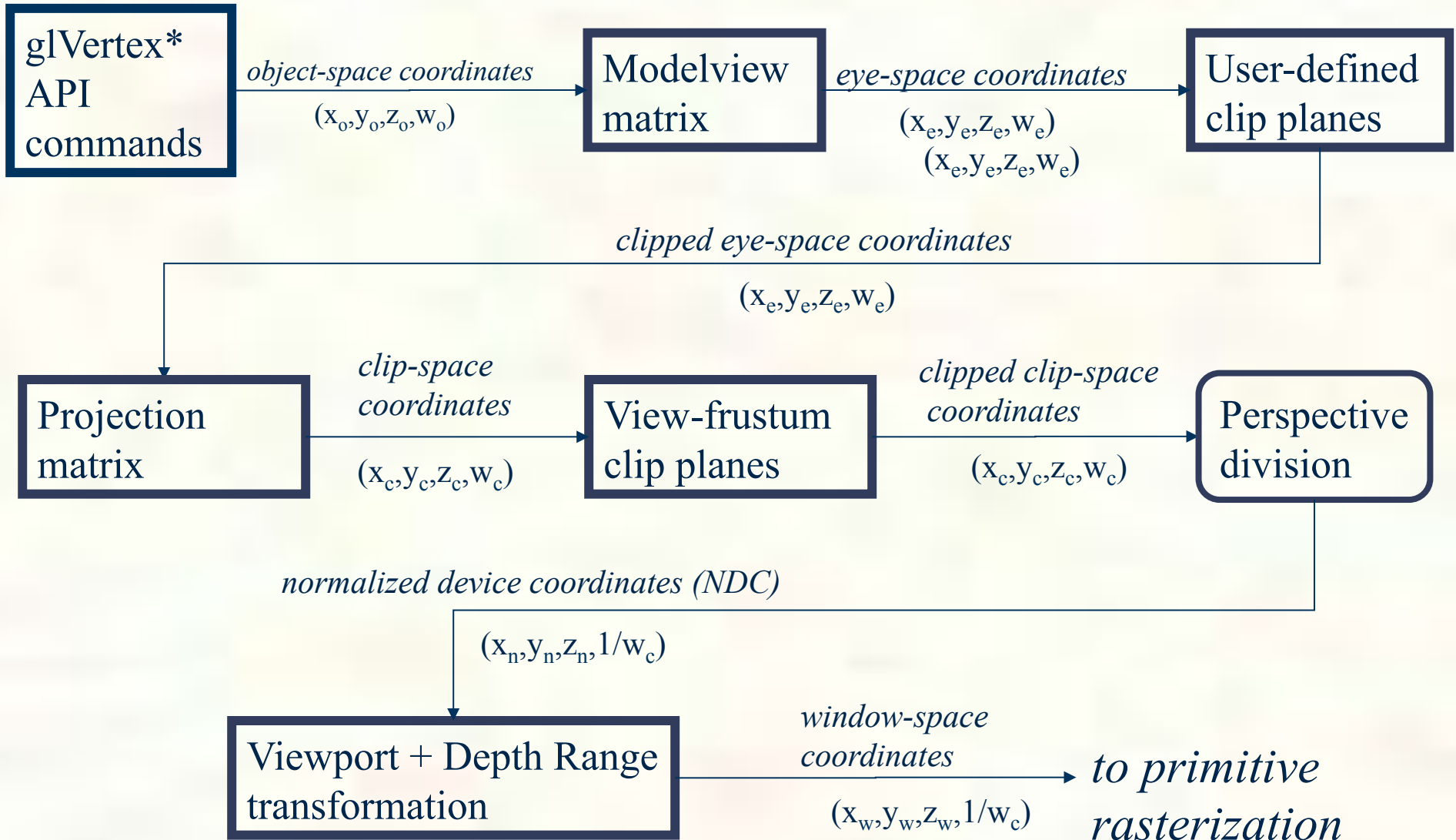



Pipeline View

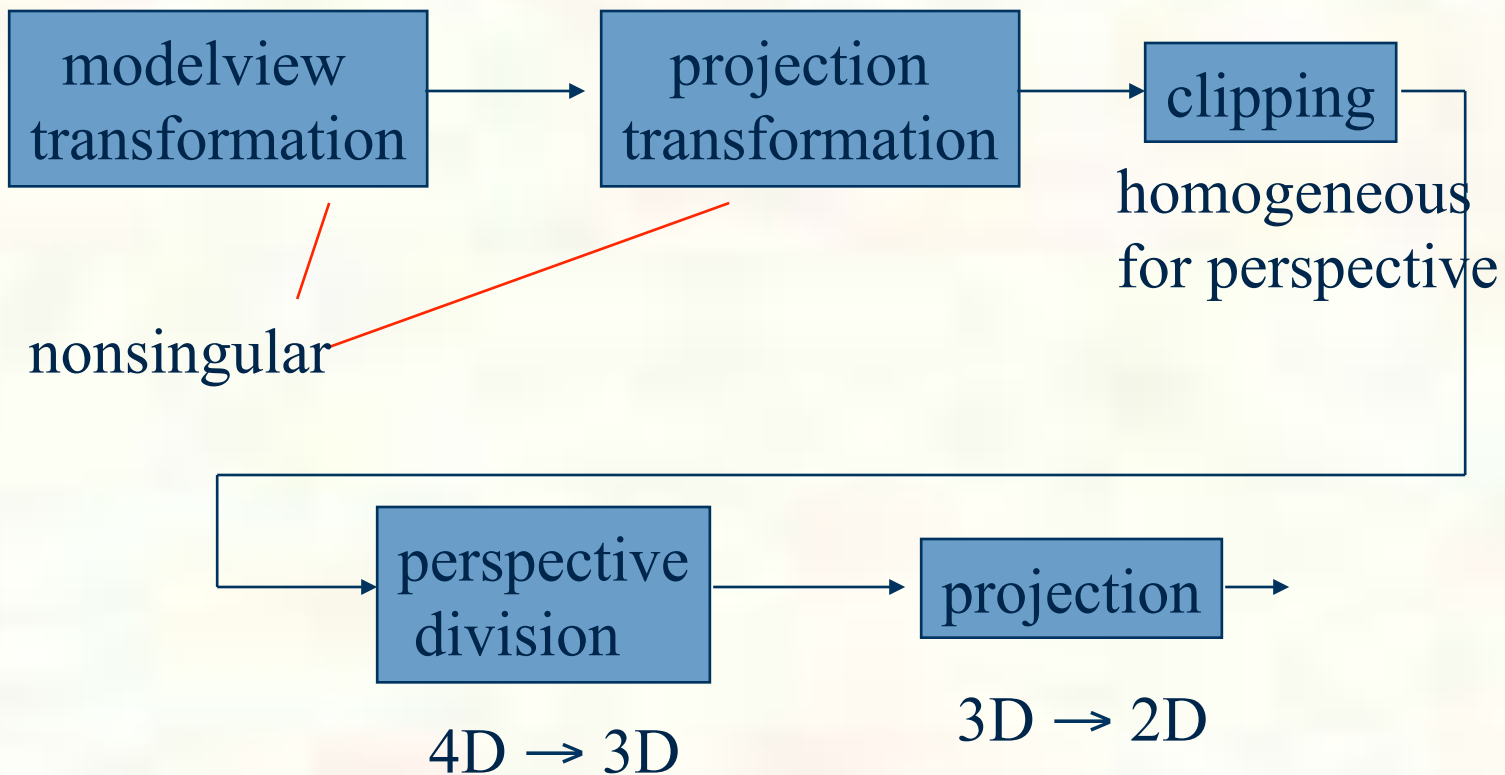



Computer Viewing

- There are three aspects of the viewing process, all of which are implemented in the pipeline,
 - Positioning the camera
 - Setting the model-view matrix
 - Selecting a lens
 - Setting the projection matrix
 - Clipping
 - Setting the view volume



The World and Camera Frames

- When we work with representations, we work with n-tuples or arrays of scalars
- Changes in frame are then defined by 4 x 4 matrices
- In OpenGL, the base frame that we start with is the world frame
- Eventually we represent entities in the camera frame by changing the world representation using the model-view matrix
- Initially these frames are the same ($\mathbf{M}=\mathbf{I}$)



Vertex Transformation

- Object-space vertex position transformed by a general linear projective transformation
 - Expressed as a 4x4 matrix

$$\begin{bmatrix} x_c \\ y_c \\ z_c \\ w_c \end{bmatrix} = \begin{bmatrix} m_0 & m_4 & m_8 & m_{12} \\ m_1 & m_5 & m_9 & m_{13} \\ m_2 & m_6 & m_{10} & m_{14} \\ m_3 & m_7 & m_{11} & m_{15} \end{bmatrix} \begin{bmatrix} x_o \\ y_o \\ z_o \\ w_o \end{bmatrix}$$



The OpenGL Camera

- In OpenGL, initially the object and camera frames are the same
 - Default model-view matrix is an identity
- The camera is located at origin and points in the negative z direction
- OpenGL also specifies a default view volume that is a cube with sides of length 2 centered at the origin
 - Default projection matrix is an identity



Moving the Camera

If objects are on both sides of $z=0$, we must move camera frame

$$\mathbf{M} = \begin{bmatrix} 1 & 0 & 0 & 0 \\ 0 & 1 & 0 & 0 \\ 0 & 0 & 1 & -d \\ 0 & 0 & 0 & 1 \end{bmatrix}$$

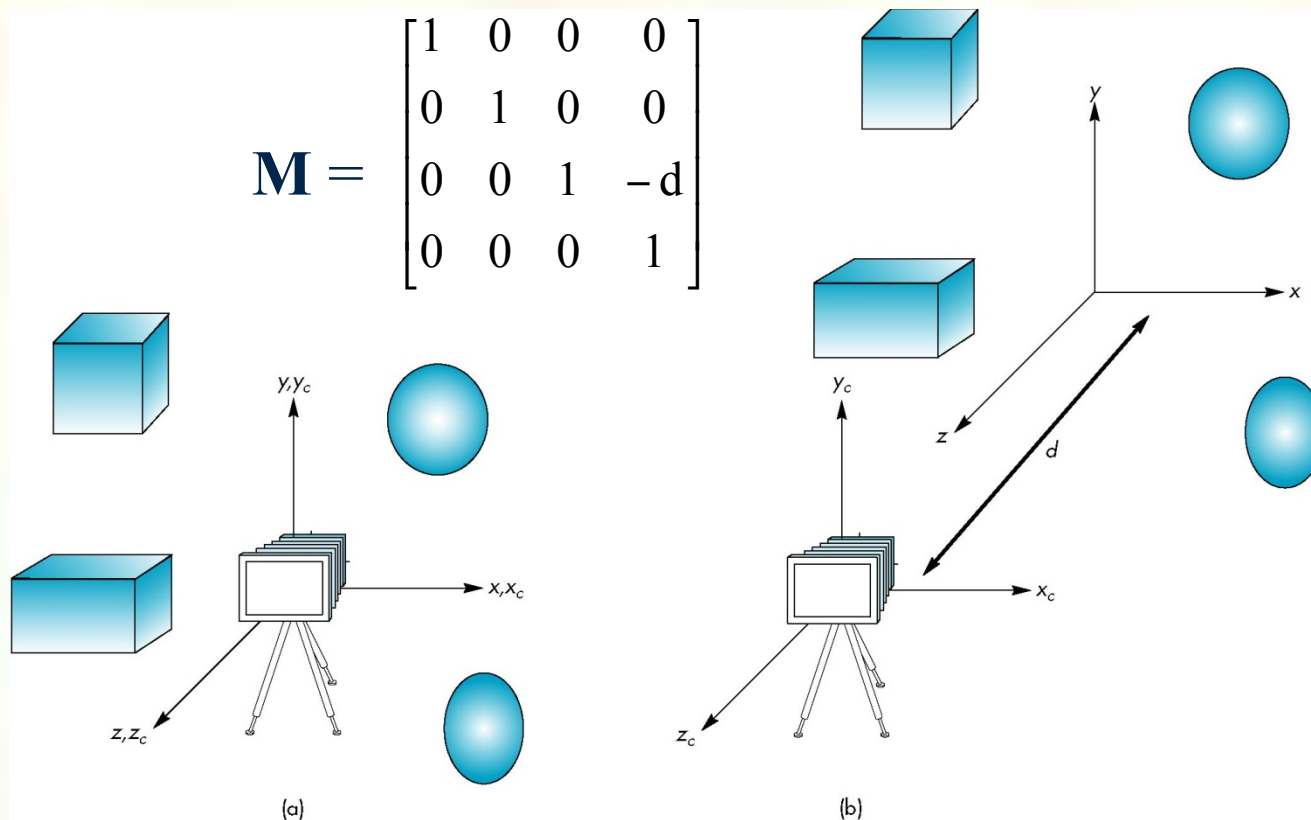



Moving the Camera Frame

- If we want to visualize object with both positive and negative z values we can either
 - Move the camera in the positive z direction
 - Translate the camera frame
 - Move the objects in the negative z direction
 - Translate the world frame
- Both of these views are equivalent and are determined by the model-view matrix
 - Want a translation (`glTranslatef(0.0, 0.0, -d);`)
 - $d > 0$



Translate Transform

- Prototype
 - `glTranslatef(GLfloat x, GLfloat y, GLfloat z)`
- Post-concatenates this matrix

$$\begin{bmatrix} 1 & 0 & 0 & x \\ 0 & 1 & 0 & y \\ 0 & 0 & 1 & z \\ 0 & 0 & 0 & 1 \end{bmatrix}$$



glTranslatef Matrix

- Modelview specification
 - `glLoadIdentity();`
`glTranslatef(0,0,-14)`
 - x translate=0, y translate=0, z translate=-14
 - Point at (0,0,0) would move to (0,0,-14)
 - Down the negative Z axis

- Matrix

$$\begin{bmatrix} 1 & 0 & 0 & x \\ 0 & 1 & 0 & y \\ 0 & 0 & 1 & z \\ 0 & 0 & 0 & 0 \end{bmatrix} = \begin{bmatrix} 1 & 0 & 0 & 0 \\ 0 & 1 & 0 & 0 \\ 0 & 0 & 1 & -14 \\ 0 & 0 & 0 & 1 \end{bmatrix}$$

the translation vector



General Camera Motion

- We can move the camera to any desired position by a sequence of rotations and translations
- Example: side view
 - Rotate the camera
 - Move it away from origin
 - Model-view matrix $C = TR$

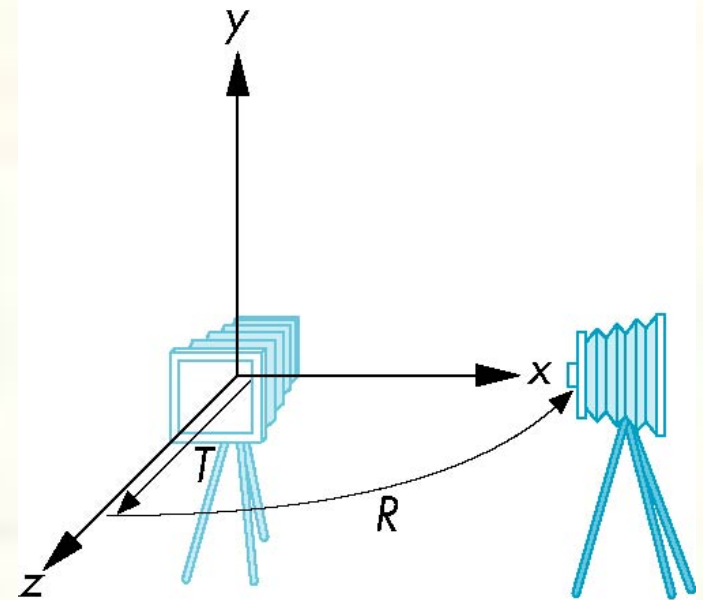



OpenGL code

- Remember that last transformation specified is first to be applied

```
glMatrixMode(GL_MODELVIEW)
glLoadIdentity();
glTranslatef(0.0, 0.0, -d);
glRotatef(90.0, 0.0, 1.0, 0.0);
```



A Better Viewing Matrix

■ “Look at” Transform

■ Concept

- Given the following
 - a 3D world-space “eye” position
 - a 3D world-space center of view position (looking “at”), and
 - an 3D world-space “up” vector
- Then an affine (non-projective) 4x4 matrix can be constructed
 - For a view transform mapping world-space to eye-space

■ A ready implementation

- The OpenGL Utility library (GLU) provides it
 - `gluLookAt(GLdouble eyex, GLdouble eyey, GLdouble eyez, GLdouble atx, GLdouble aty, GLdouble atz, GLdouble upx, GLdouble upy, GLdouble upz);`

Primary OpenGL libraries

Link with `-lglut` for GLUT

Link with `-lGLU` for GLU

Link with `-lGL` for OpenGL



gluLookAt

`gluLookAt(eyex, eyey, eyez, atx, aty, atz, upx, upy, upz)`

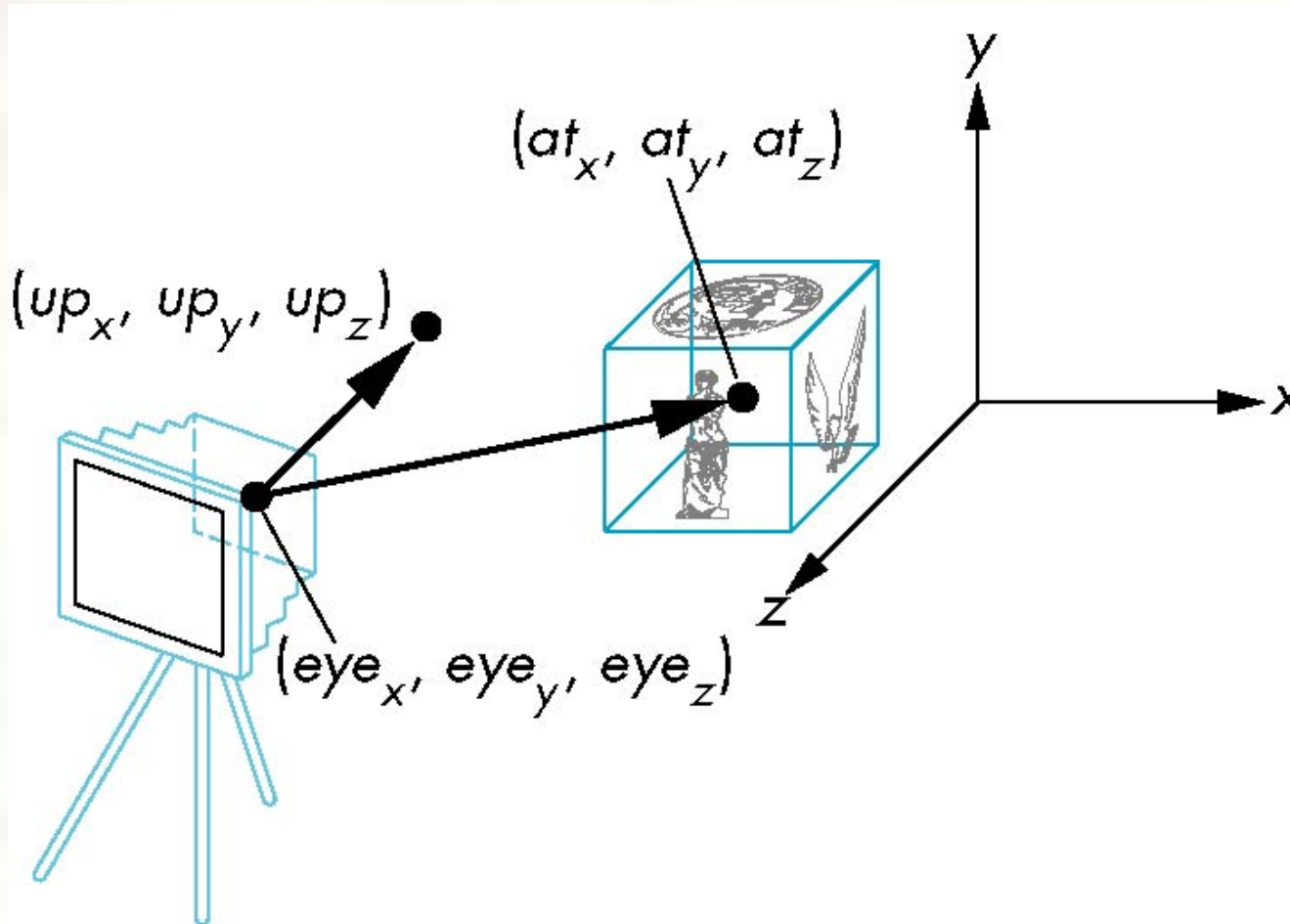



“Look At” in Practice

- Consider our prior view situation
 - Instead of an arbitrary view...
 - ...we just translated by 14 in negative Z direction
 - `glTranslatef(0,0,14)`
- What this means in “Look At” parameters
 - $(\text{eyex}, \text{eyey}, \text{eyez}) = (0, 0, 14)$
 - $(\text{atx}, \text{aty}, \text{atz}) = (0, 0, 0)$
 - $(\text{upx}, \text{upy}, \text{upz}) = (0, 1, 0)$

*Not surprising both are “just translates in Z”
since the “Look At” parameters
already have use looking down the negative Z axis*

`glTranslatef(0,0,-14)`

$$\begin{bmatrix} 1 & 0 & 0 & 0 \\ 0 & 1 & 0 & 0 \\ 0 & 0 & 1 & -14 \\ 0 & 0 & 0 & 1 \end{bmatrix}$$

*Same matrix;
same transform*

`gluLookAt(0,0,14,
0,0,0,
0,1,0)`

$$\begin{bmatrix} 1 & 0 & 0 & 0 \\ 0 & 1 & 0 & 0 \\ 0 & 0 & 1 & -14 \\ 0 & 0 & 0 & 1 \end{bmatrix}$$



The “Look At” Algorithm

■ Vector math

- $Z = \text{eye} - \text{at}$
- $Z = \text{normalize}(Z)$ /* normalize means $Z / \text{length}(Z)$ */
- $Y = \text{up}$
- $X = Y \times Z$ /* \times means vector cross product! */
- $Y = Z \times X$ /* orthogonalize */
- $X = \text{normalize}(X)$
- $Y = \text{normalize}(Y)$

■ Then build the following affine 4x4 matrix

$$\begin{bmatrix} X_x & X_y & X_z & -X \cdot \text{eye} \\ Y_x & Y_y & Y_z & -Y \cdot \text{eye} \\ Z_x & Z_y & Z_z & -Z \cdot \text{eye} \\ 0 & 0 & 0 & 1 \end{bmatrix}$$

Warning: Algorithm is prone to failure if normalize divides by zero (or very nearly does)

So

1. Don't let Z or up be zero length vectors
2. Don't let Z and up be coincident vectors



“Look At” Examples

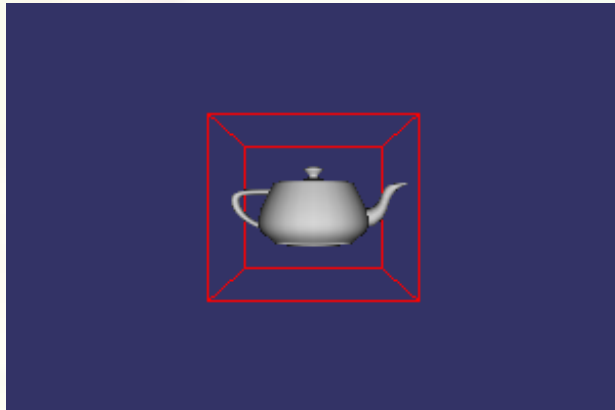

```
gluLookAt(0,0,14, // eye (x,y,z)
          0,0,0,   // at (x,y,z)
          0,1,0); // up (x,y,z)
```

Same as the `glTranslatef(0,0,-14)` as expected

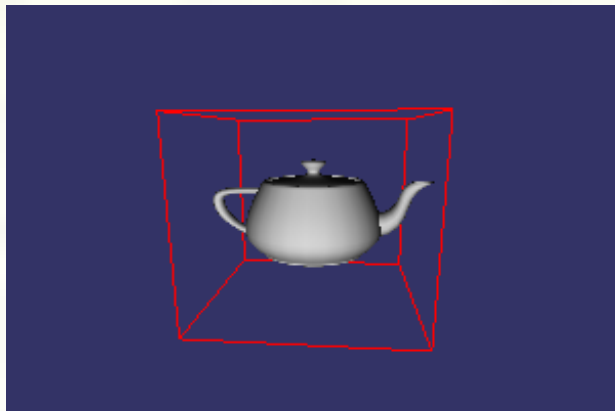

```
gluLookAt(1,2.5,11, // eye (x,y,z)
          0,0,0,   // at (x,y,z)
          0,1,0); // up (x,y,z)
```

Similar to original, but just a little off angle due to slightly perturbed eye vector



“Look At” Major Eye Changes

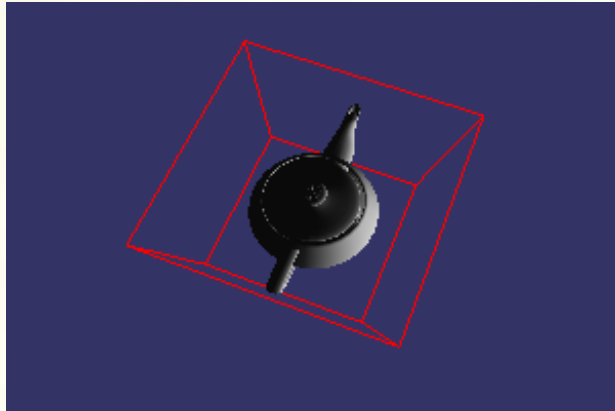

```
gluLookAt(-2.5,11,1, // eye (x,y,z)
           0,0,0,     // at (x,y,z)
           0,1,0);   // up (x,y,z)
```

Eye is “above” the scene

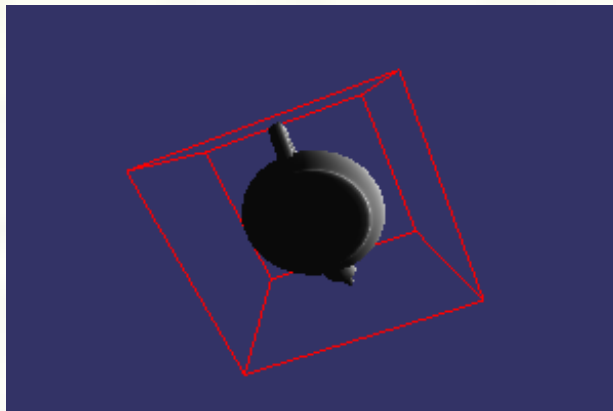

```
gluLookAt(-2.5,-11,1, // eye (x,y,z)
           0,0,0,     // at (x,y,z)
           0,1,0);   // up (x,y,z)
```

Eye is “below” the scene



“Look At” Changes to AT and UP

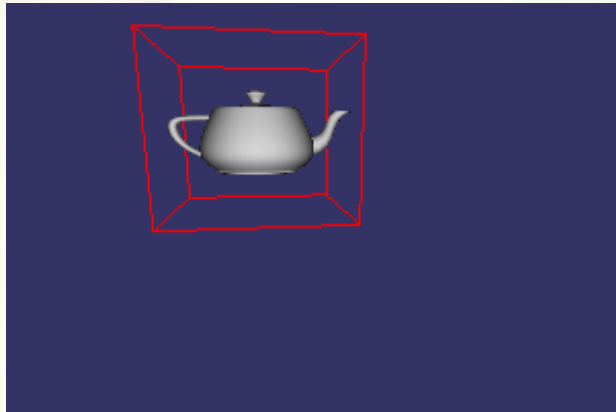

```
gluLookAt(0,0,14, // eye (x,y,z)
          2,-3,0,  // at (x,y,z)
          0,1,0); // up (x,y,z)
```

Original eye position, but “at” position shifted

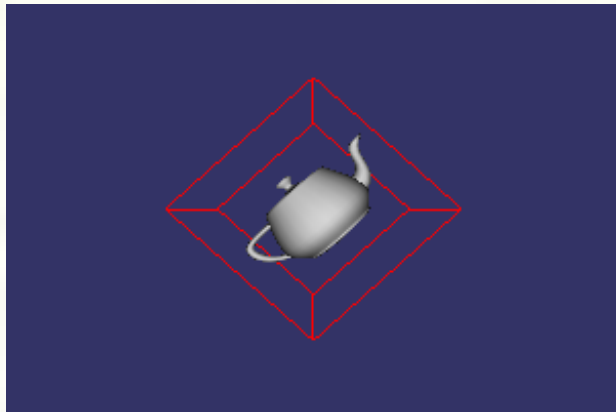

```
gluLookAt(0,0,14, // eye (x,y,z)
          0,0,0,  // at (x,y,z)
          1,1,0); // up (x,y,z)
```

Eye is “below” the scene



The LookAt Function

- The GLU library contains the function `gluLookAt` to form the required modelview matrix through a simple interface
- Note the need for setting an up direction
- Still need to initialize
- Can concatenate with modeling transformations
- Example: isometric view of cube aligned with axes

```
glMatrixMode(GL_MODELVIEW) ;  
glLoadIdentity() ;  
gluLookAt(1.0, 1.0, 1.0, 0.0, 0.0, 0.0, 0., 1.0, 0.0) ;
```



Other Viewing APIs

- The LookAt function is only one possible API for positioning the camera
- Others include
 - View reference point, view plane normal, view up (PHIGS, GKS-3D)
 - Yaw, pitch, roll
 - Elevation, azimuth, twist
 - Direction angles



Two Transforms in Sequence

- OpenGL thinks of the projective transform as really two 4x4 matrix transforms

FIRST
object-space
to
eye-space

$$\begin{bmatrix} x_e \\ y_e \\ z_e \\ w_e \end{bmatrix} = \begin{bmatrix} MV_0 & MV_4 & MV_8 & MV_{12} \\ MV_1 & MV_5 & MV_9 & MV_{13} \\ MV_2 & MV_6 & MV_{10} & MV_{14} \\ MV_3 & MV_7 & MV_{11} & MV_{15} \end{bmatrix} \begin{bmatrix} x_o \\ y_o \\ z_o \\ w_o \end{bmatrix}$$

16 Multiply-Add
operations

SECOND
eye-space
to
clip-space

$$\begin{bmatrix} x_c \\ y_c \\ z_c \\ w_c \end{bmatrix} = \begin{bmatrix} P_0 & P_4 & P_8 & P_{12} \\ P_1 & P_5 & P_9 & P_{13} \\ P_2 & P_6 & P_{10} & P_{14} \\ P_3 & P_7 & P_{11} & P_{15} \end{bmatrix} \begin{bmatrix} x_e \\ y_e \\ z_e \\ w_e \end{bmatrix}$$

Another
16 Multiply-Add
operations



Modelview-Projection Transform

- Matrixes can associate (combine)
 - Combination of the modelview and projection matrix = modelview-projection matrix
 - or often simply the “MVP” matrix

$$\begin{bmatrix} MVP_0 & MVP_4 & MVP_8 & MVP_{12} \\ MVP_1 & MVP_5 & MVP_9 & MVP_{13} \\ MVP_2 & MVP_6 & MVP_{10} & MVP_{14} \\ MVP_3 & MVP_7 & MVP_{11} & MVP_{15} \end{bmatrix} = \begin{bmatrix} P_0 & P_4 & P_8 & P_{12} \\ P_1 & P_5 & P_9 & P_{13} \\ P_2 & P_6 & P_{10} & P_{14} \\ P_3 & P_7 & P_{11} & P_{15} \end{bmatrix} \begin{bmatrix} MV_0 & MV_4 & MV_8 & MV_{12} \\ MV_1 & MV_5 & MV_9 & MV_{13} \\ MV_2 & MV_6 & MV_{10} & MV_{14} \\ MV_3 & MV_7 & MV_{11} & MV_{15} \end{bmatrix}$$

Matrix multiplication
is **associative** (but not commutative)
 $A(BC) = (AB)C$, but $ABC \neq CBA$

concatenation is
64 Multiply-Add
operations, done by OpenGL driver



Specifying the Transforms

- Specified in two parts

- First the projection

- `glMatrixMode(GL_PROJECTION);`
- `glLoadIdentity();`
- `glFrustum(-4, +4, // left & right
 -3, +3, // top & bottom
 5, 80); // near & far`

Resulting projection matrix

$$\begin{bmatrix} 1.25 & 0 & 0 & 0 \\ 0 & 1.667 & 0 & 0 \\ 0 & 0 & -1.1333 & -10.667 \\ 0 & 0 & -1 & 0 \end{bmatrix}$$

- Second the model-view

- `glMatrixMode(GL_MODELVIEW);`
- `glLoadIdentity();`
- `glTranslatef(0, 0, -14);`
 - So objects centered at (0,0,0) would be at (0,0,-14) in eye-space

Resulting modelview matrix

$$\begin{bmatrix} 1 & 0 & 0 & 0 \\ 0 & 1 & 0 & 0 \\ 0 & 0 & 1 & -14 \\ 0 & 0 & 0 & 1 \end{bmatrix}$$



Modelview-Projection Matrix

- Transform composition via matrix multiplication

$$\begin{bmatrix} 1.25 & 0 & 0 & 0 \\ 0 & 1.667 & 0 & 0 \\ 0 & 0 & -1.1333 & -10.667 \\ 0 & 0 & -1 & 0 \end{bmatrix} \begin{bmatrix} 1 & 0 & 0 & 0 \\ 0 & 1 & 0 & 0 \\ 0 & 0 & 1 & -14 \\ 0 & 0 & 0 & 1 \end{bmatrix} \\ = \begin{bmatrix} 1.25 & 0 & 0 & 0 \\ 0 & 1.667 & 0 & 0 \\ 0 & 0 & -1.1333 & 5.2 \\ 0 & 0 & -1 & 14 \end{bmatrix}$$

Resulting modelview-projection matrix



Now Draw Some Objects

- Draw a wireframe cube
 - `glColor3f(1,0,0); // red`
 - `glutWireCube(6);`
 - 6x6x6 unit cube centered at origin (0,0,0)
- Draw a teapot in the cube
 - `glColor3f(0,0,1); // blue`
 - `glutSolidTeapot(2.0);`
 - centered at the origin (0,0,0)
 - handle and spout point down the X axis
 - top and bottom in the Y axis
- *As we'd expect given a frustum transform, the cube is in perspective*
 - The teapot is too but more obvious to observe with a wireframe cube

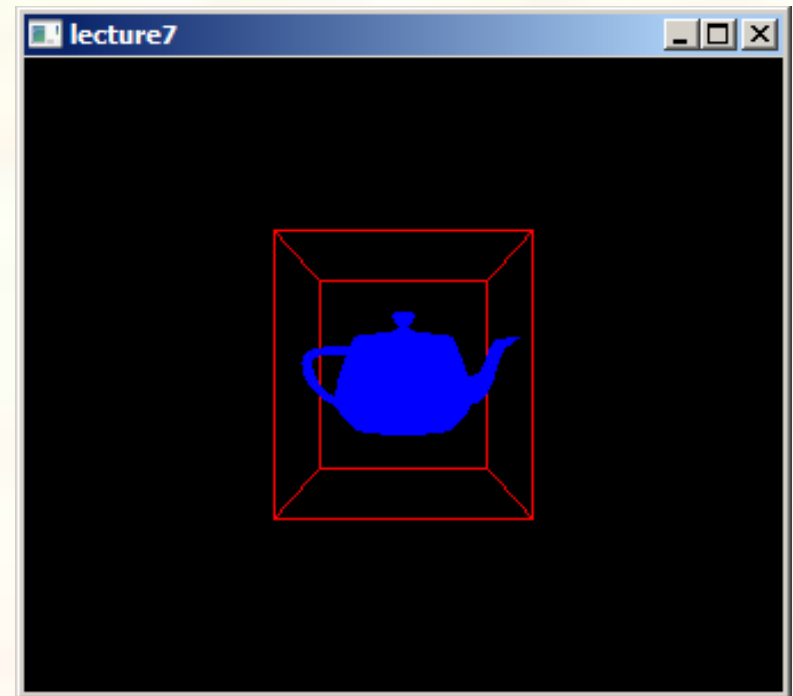



What We've Accomplished

- Simple perspective

- With `glFrustum`
- Establishes how eye-space maps to clip-space

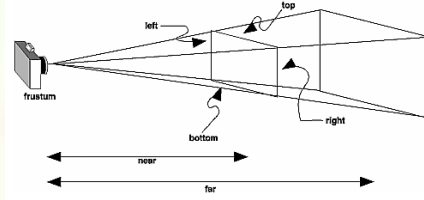

- Simple viewing

- With `glTranslatef`
- Establishes how world-space maps to eye-space
- All we really did was “wheel” the camera 14 units up the Z axis
- No actual “modeling transforms”, just viewing
 - Modeling would be rotating, scaling, or otherwise transform the objects with the view
 - Arguably the modelview matrix is really just a “view” matrix in this example

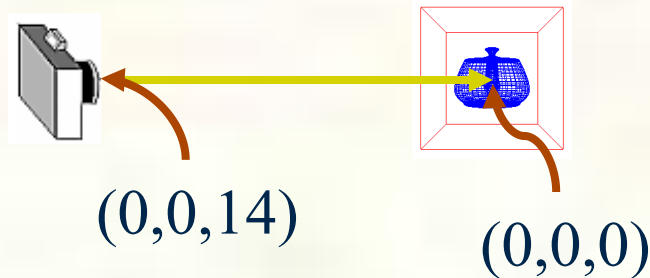



Some Simple Modeling

- Try some modeling transforms to move teapot
 - But leave the cube alone for reference

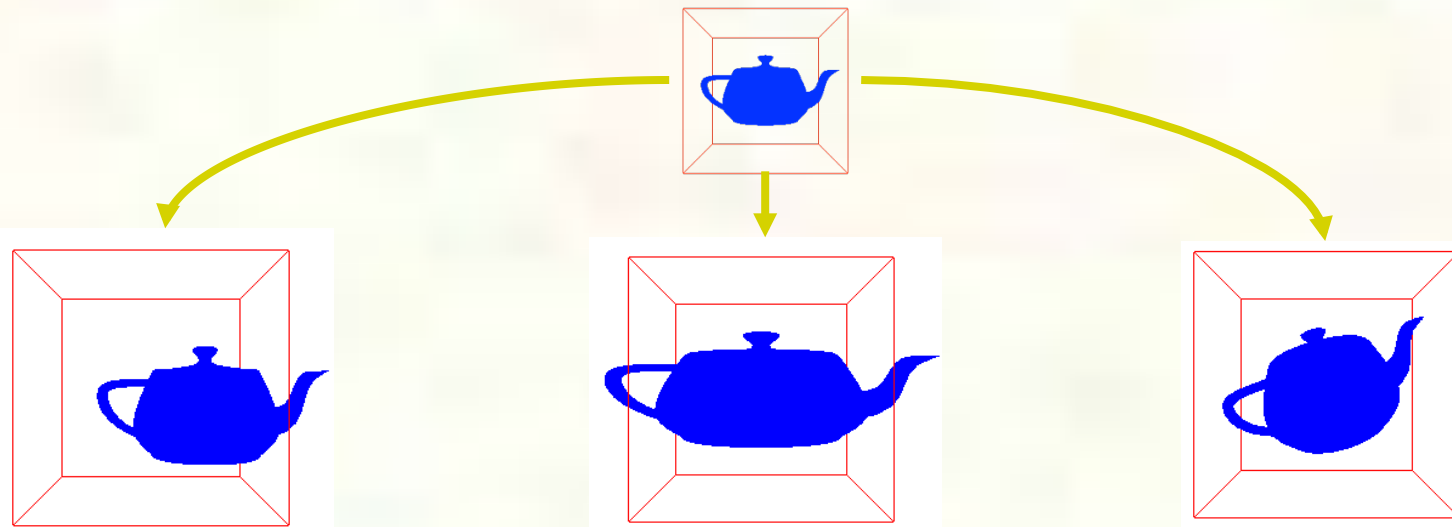

```
glPushMatrix(); {  
  glTranslatef(1.5, -0.5, 0);  
  glutSolidTeapot(2.0);  
} glPopMatrix();
```

```
glPushMatrix(); {  
  glScalef(1.5, 1.0, 1.5);  
  glutSolidTeapot(2.0);  
} glPopMatrix();
```

```
glPushMatrix(); {  
  glRotatef(30, 1,1,1);  
  glutSolidTeapot(2.0);  
} glPopMatrix();
```

We “bracket” the modeling transform with `glPushMatrix/glPopMatrix` commands so the modeling transforms are “localized” to the particular object



Add Some Lighting

- Some lighting makes the modeling more intuitive

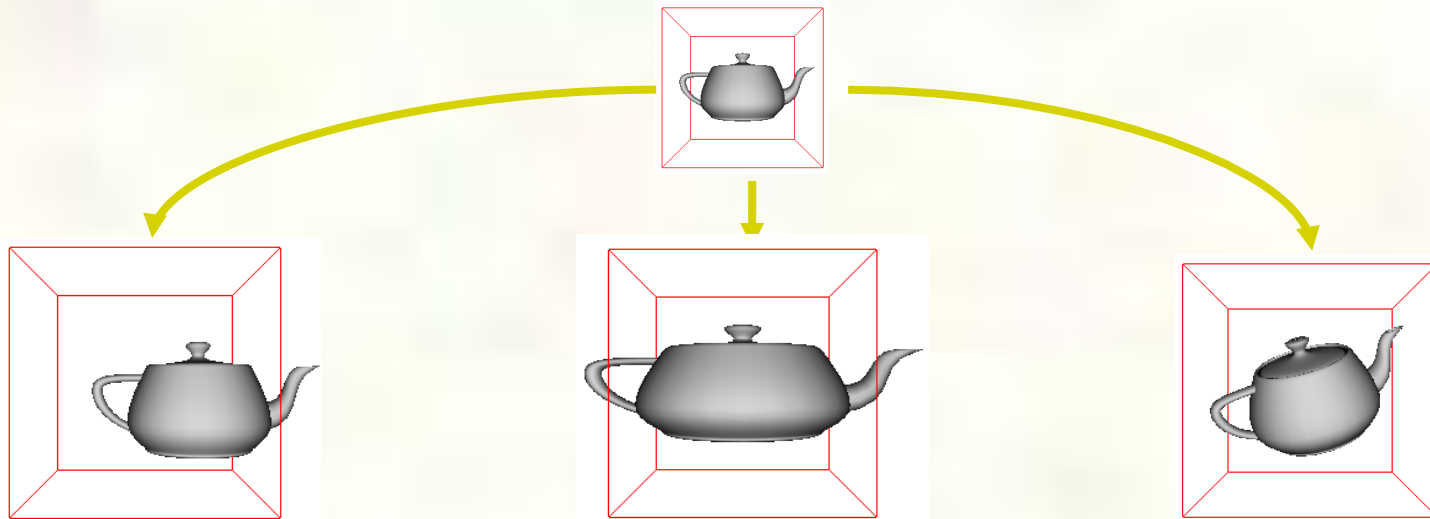

```
glPushMatrix(); {  
  glTranslatef(1.5, -0.5, 0);  
  glutSolidTeapot(2.0);  
} glPopMatrix();
```

```
glPushMatrix(); {  
  glScalef(1.5, 1.0, 1.5);  
  glutSolidTeapot(2.0);  
} glPopMatrix();
```

```
glPushMatrix(); {  
  glRotatef(30, 1,1,1);  
  glutSolidTeapot(2.0);  
} glPopMatrix();
```

We've not discussed lighting yet but per-vertex lighting allows a virtual light source to “interact” with the object's surface orientation and material properties



Modelview-Projection Matrix

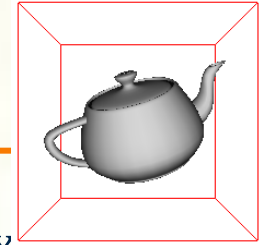

- Let's consider the "combined" modelview matrix with the rotation

- glRotate(30, 1,1,1) defines a rotation matrix

- Rotating 30 degrees...
- ...around an axis in the (1,1,1) direction

$$\begin{bmatrix} 0.9107 & -0.2440 & 0.3333 & 0 \\ 0.3333 & 0.9107 & -0.2440 & 0 \\ -0.2440 & 0.3333 & 0.9107 & 0 \\ 0 & 0 & 0 & 1 \end{bmatrix}$$

$$\underbrace{\begin{bmatrix} 1.25 & 0 & 0 & 0 \\ 0 & 1.667 & 0 & 0 \\ 0 & 0 & -1.1333 & -10.667 \\ 0 & 0 & -1 & 0 \end{bmatrix}}_{\text{projection}} \underbrace{\begin{bmatrix} 1 & 0 & 0 & 0 \\ 0 & 1 & 0 & 0 \\ 0 & 0 & 1 & -14 \\ 0 & 0 & 0 & 1 \end{bmatrix}}_{\text{view}} \underbrace{\begin{bmatrix} 0.9107 & -0.2440 & 0.3333 & 0 \\ 0.3333 & 0.9107 & -0.2440 & 0 \\ -0.2440 & 0.3333 & 0.9107 & 0 \\ 0 & 0 & 0 & 1 \end{bmatrix}}_{\text{model}}$$



Combining All Three

Matrix-by-matrix multiplication is associative so

$$PVM = P(VM) = (P V) M$$

OpenGL keeps V and M "together" because eye-space is a convenient space for lighting

$$\underbrace{\begin{bmatrix} 1 & 0 & 0 & 0 \\ 0 & 1 & 0 & 0 \\ 0 & 0 & 1 & -14 \\ 0 & 0 & 0 & 1 \end{bmatrix}}_{\text{view}} \underbrace{\begin{bmatrix} 0.9107 & -0.2440 & 0.3333 & 0 \\ 0.3333 & 0.9107 & -0.2440 & 0 \\ -0.2440 & 0.3333 & 0.9107 & 0 \\ 0 & 0 & 0 & 1 \end{bmatrix}}_{\text{model}}$$

$$\underbrace{\begin{bmatrix} 1.25 & 0 & 0 & 0 \\ 0 & 1.667 & 0 & 0 \\ 0 & 0 & -1.1333 & -10.667 \\ 0 & 0 & -1 & 0 \end{bmatrix}}_{\text{projection}} \underbrace{\begin{bmatrix} 0.9107 & -0.2440 & 0.3333 & 0 \\ 0.3333 & 0.9107 & -0.2440 & 0 \\ -0.2440 & 0.3333 & 0.9107 & -14 \\ 0 & 0 & 0 & 1 \end{bmatrix}}_{\text{modelview}}$$

$$\underbrace{\begin{bmatrix} 1.1384 & -0.3050 & 0.4167 & 0 \\ 0.5556 & 1.5178 & -0.4067 & 0 \\ 0.2766 & -0.3778 & -1.0321 & 5.2 \\ 0.2440 & -0.3333 & -0.9107 & 14 \end{bmatrix}}_{\text{modelview-projection}}$$



Object- to Clip-space

model

$$\begin{bmatrix} x_{world} \\ y_{world} \\ z_{world} \\ w_{world} \end{bmatrix} = \begin{bmatrix} 0.9107 & -0.2440 & 0.3333 & 0 \\ 0.3333 & 0.9107 & -0.2440 & 0 \\ -0.2440 & 0.3333 & 0.9107 & 0 \\ 0 & 0 & 0 & 1 \end{bmatrix} \begin{bmatrix} x_{object} \\ y_{object} \\ z_{object} \\ w_{object} \end{bmatrix}$$

view

$$\begin{bmatrix} x_{eye} \\ y_{eye} \\ z_{eye} \\ w_{eye} \end{bmatrix} = \begin{bmatrix} 1 & 0 & 0 & 0 \\ 0 & 1 & 0 & 0 \\ 0 & 0 & 1 & -14 \\ 0 & 0 & 0 & 1 \end{bmatrix} \begin{bmatrix} x_{world} \\ y_{world} \\ z_{world} \\ w_{world} \end{bmatrix}$$

projection

$$\begin{bmatrix} x_{clip} \\ y_{clip} \\ z_{clip} \\ w_{clip} \end{bmatrix} = \begin{bmatrix} 1.25 & 0 & 0 & 0 \\ 0 & 1.667 & 0 & 0 \\ 0 & 0 & -1.1333 & -10.667 \\ 0 & 0 & -1 & 0 \end{bmatrix} \begin{bmatrix} x_{eye} \\ y_{eye} \\ z_{eye} \\ w_{eye} \end{bmatrix}$$

object-to-world-to-eye-to-clip

modelview

$$\begin{bmatrix} x_{eye} \\ y_{eye} \\ z_{eye} \\ w_{eye} \end{bmatrix} = \begin{bmatrix} 0.9107 & -0.2440 & 0.3333 & 0 \\ 0.3333 & 0.9107 & -0.2440 & 0 \\ -0.2440 & 0.3333 & 0.9107 & -14 \\ 0 & 0 & 0 & 1 \end{bmatrix} \begin{bmatrix} x_{object} \\ y_{object} \\ z_{object} \\ w_{object} \end{bmatrix}$$

projection

$$\begin{bmatrix} x_{clip} \\ y_{clip} \\ z_{clip} \\ w_{clip} \end{bmatrix} = \begin{bmatrix} 1.25 & 0 & 0 & 0 \\ 0 & 1.667 & 0 & 0 \\ 0 & 0 & -1.1333 & -10.667 \\ 0 & 0 & -1 & 0 \end{bmatrix} \begin{bmatrix} x_{eye} \\ y_{eye} \\ z_{eye} \\ w_{eye} \end{bmatrix}$$

object-to-eye-to-clip

modelview-projection

$$\begin{bmatrix} x_{clip} \\ y_{clip} \\ z_{clip} \\ w_{clip} \end{bmatrix} = \begin{bmatrix} 1.1384 & -0.3050 & 0.4167 & 0 \\ 0.5556 & 1.5178 & -0.4067 & 0 \\ 0.2766 & -0.3778 & -1.0321 & 5.2 \\ 0.2440 & -0.3333 & -0.9107 & 14 \end{bmatrix} \begin{bmatrix} x_{object} \\ y_{object} \\ z_{object} \\ w_{object} \end{bmatrix}$$

object-to-clip



Complex Scene Example



Each character, wall, ceiling, floor, and light have their own modeling transformation



Representing Objects

- Interested in object's boundary
- Various approaches

- Procedural representations
 - Often fractal

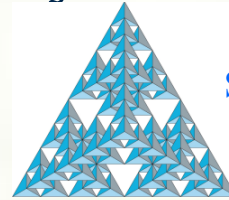

Sierpinski gasket

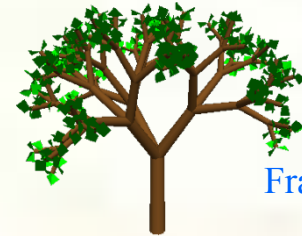

Fractal tree

[Philip Winston]

- Explicit polygon (triangle) meshes
 - By far, the most popular method

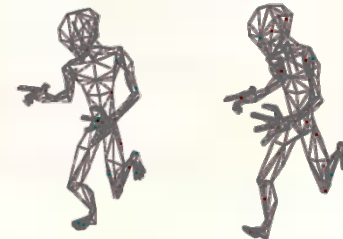

Quake 2 key frame triangle meshes

- Curved surface patches
 - Often displacement mapped

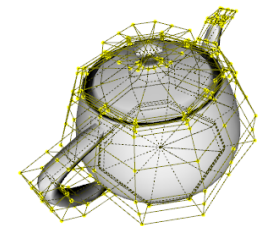

Utah Teapot

- Implicit representation
 - Blobby, volumetric

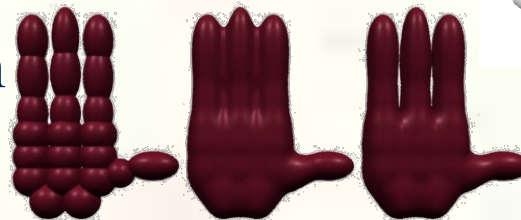

Blobby modeling in RenderMan



Focus on Triangle Meshes

- Easiest approach to representing object boundaries
- So what is a mesh and how should it be stored?
 - Simplest view
 - A set of triangles, each with its “own” 3 vertices
 - Essentially “triangle soup”
 - Yet triangles in meshes share edges by design
 - Sharing edges implies sharing vertices
 - More sophisticated view
 - Store single set of unique vertexes in array
 - Then each primitive (triangle) specifies 3 indices into array of vertexes
 - More compact
 - Vertex data size \gg index size
 - Avoids redundant vertex data
 - Separates “topology” (how the mesh is connected) from its “geometry” (vertex positions and attributes)
 - Connectivity can be deduced more easily
 - Makes mesh processing algorithms easier
 - Geometry data can change without altering the topology



Consider a Tetrahedron

- Simplest closed volume
 - Consists of 4 triangles and 4 vertices
 - (and 4 edges)

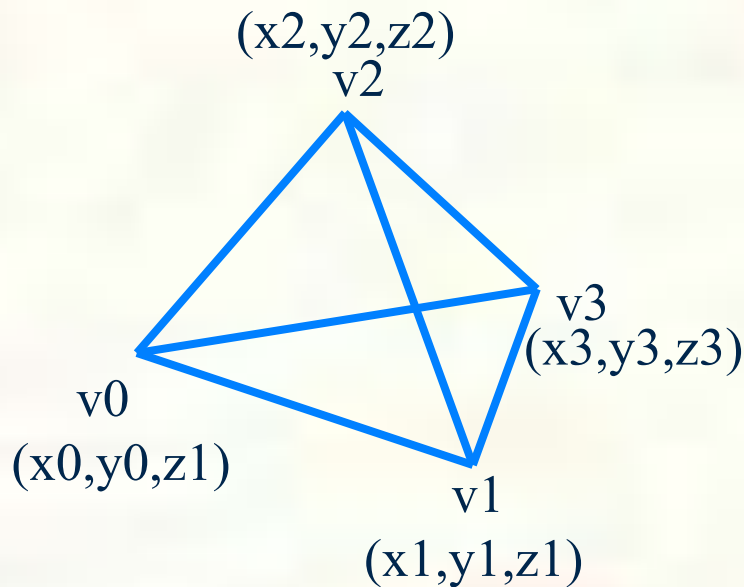

triangle list

0: v_0, v_1, v_2

1: v_1, v_3, v_2

2: v_3, v_0, v_2

3: v_1, v_0, v_3

topology

vertex list

0: (x_0, y_0, z_0)

1: (x_1, y_1, z_1)

2: (x_2, y_2, z_2)

3: (x_3, y_3, z_3)

geometry

potentially on-GPU!



Benefits of Vertex Array Approach

- Unique vertices are stored once
 - Saves memory
 - On CPU, on disk, and on GPU
- Matches OpenGL vertex array model of operation
 - And this matches the efficient GPU mode of operation
 - The GPU can “cache” post-transformed vertex results by vertex index
 - Saves retransformation and redundant vertex fetching
 - Direct3D has the same model
 - Allows vertex data to be stored on-GPU for even faster vertex processing
 - OpenGL supported vertex buffer objects for this



Next Lecture

- More about triangle mesh representation
- Scene graphs